



Instructions

A622 100 Amp AC/DC Current Probe 070-8883-03



070888303

Copyright © Tektronix, Inc. All rights reserved.

Tektronix products are covered by U.S. and foreign patents, issued and pending. Information in this publication supercedes that in all previously published material. Specifications and price change privileges reserved.

Tektronix, Inc., P.O. Box 500, Beaverton, OR 97077

TEKTRONIX and TEK are registered trademarks of Tektronix, Inc.

Warranty 2

Tektronix warrants that this product will be free from defects in materials and workmanship for a period of one (1) year from the date of shipment. If any such product proves defective during this warranty period, Tektronix, at its option, either will repair the defective product without charge for parts and labor, or will provide a replacement in exchange for the defective product. Parts, modules and replacement products used by Tektronix for warranty work may be new or reconditioned to like new performance. All replaced parts, modules and products become the property of Tektronix.

In order to obtain service under this warranty, Customer must notify Tektronix of the defect before the expiration of the warranty period and make suitable arrangements for the performance of service. Customer shall be responsible for packaging and shipping the defective product to the service center designated by Tektronix, with shipping charges prepaid. Tektronix shall pay for the return of the product to Customer if the shipment is to a location within the country in which the Tektronix service center is located. Customer shall be responsible for paying all shipping charges, duties, taxes, and any other charges for products returned to any other locations.

This warranty shall not apply to any defect, failure or damage caused by improper use or improper or inadequate maintenance and care. Tektronix shall not be obligated to furnish service under this warranty a) to repair damage resulting from attempts by personnel other than Tektronix representatives to install, repair or service the product; b) to repair damage resulting from improper use or connection to incompatible equipment; c) to repair any damage or malfunction caused by the use of non-Tektronix supplies; or d) to service a product that has been modified or integrated with other products when the effect of such modification or integration increases the time or difficulty of servicing the product.

THIS WARRANTY IS GIVEN BY TEKTRONIX WITH RESPECT TO THE PRODUCT IN LIEU OF ANY OTHER WARRANTIES, EXPRESS OR IMPLIED. TEKTRONIX AND ITS VENDORS DISCLAIM ANY IMPLIED WARRANTIES OF MERCHANTABILITY OR FITNESS FOR A PARTICULAR PURPOSE. TEKTRONIX' RESPONSIBILITY TO REPAIR OR REPLACE DEFECTIVE PRODUCTS IS THE SOLE AND EXCLUSIVE REMEDY PROVIDED TO THE CUSTOMER FOR BREACH OF THIS WARRANTY. TEKTRONIX AND ITS VENDORS WILL NOT BE LIABLE FOR ANY INDIRECT, SPECIAL, INCIDENTAL, OR CONSEQUENTIAL DAMAGES IRRESPECTIVE OF WHETHER TEKTRONIX OR THE VENDOR HAS ADVANCE NOTICE OF THE POSSIBILITY OF SUCH DAMAGES.

Contacting Tektronix

Phone	1-800-833-9200*
Address	Tektronix, Inc. Department or name (if known) 14200 SW Karl Braun Drive P.O. Box 500 Beaverton, OR 97077 USA
Web site	www.tektronix.com
Sales support	1-800-833-9200, select option 1*
Service support	1-800-833-9200, select option 2*
Technical support	www.tektronix.com/support 1-800-833-9200, select option 3* 6:00 a.m. – 5:00 p.m. Pacific Standard Time

* This phone number is toll free in North America. After office hours, please leave a voice mail message.
Outside North America, contact a Tektronix sales office or distributor; see the Tektronix web site for a list of offices.



General Safety Summary

Review the following safety precautions to avoid injury and prevent damage to this product or any products connected to it. To avoid potential hazards, use this product only as specified.

Only qualified personnel should perform service procedures.

To Avoid Fire or Personal Injury

Connect and Disconnect Properly. Connect the probe output to the measurement instrument before connecting the probe to the circuit under test. Disconnect the probe input and the probe ground from the circuit under test before disconnecting the probe from the measurement instrument.

Observe All Terminal Ratings. To avoid fire or shock hazard, observe all ratings and markings on the product. Consult the product manual for further ratings information before making connections to the product.

Replace Batteries Properly. Replace batteries only with the proper type and rating specified.

Do Not Operate Without Covers. Do not operate this product with covers or panels removed.

Avoid Exposed Circuitry. Do not touch exposed connections and components when power is present.

Do Not Operate With Suspected Failures. If you suspect there is damage to this product, have it inspected by qualified service personnel.

Do Not Operate in Wet/Damp Conditions.

Do Not Operate in an Explosive Atmosphere.

Keep Product Surfaces Clean and Dry.

Safety Terms and Symbols

Terms in This Manual. These terms may appear in this manual:



WARNING. *Warning statements identify conditions or practices that could result in injury or loss of life.*



CAUTION. *Caution statements identify conditions or practices that could result in damage to this product or other property.*

Terms on the Product. These terms may appear on the product:

DANGER indicates an injury hazard immediately accessible as you read the marking.

WARNING indicates an injury hazard not immediately accessible as you read the marking.

CAUTION indicates a hazard to property including the product.

Symbols on the Product. These symbols may appear on the product:



CAUTION
Refer to Manual



Double
Insulated

Getting Started

The A622 current probe (Figure 1) enables a general purpose oscilloscope to display AC and DC current signals up to 100 amps Peak (70 A RMS). The A622 current probe can also make AC and DC measurements with a multimeter by using the BNC-to-banana plug adapter that is available as a recommended accessory. See page 17 for ordering information.

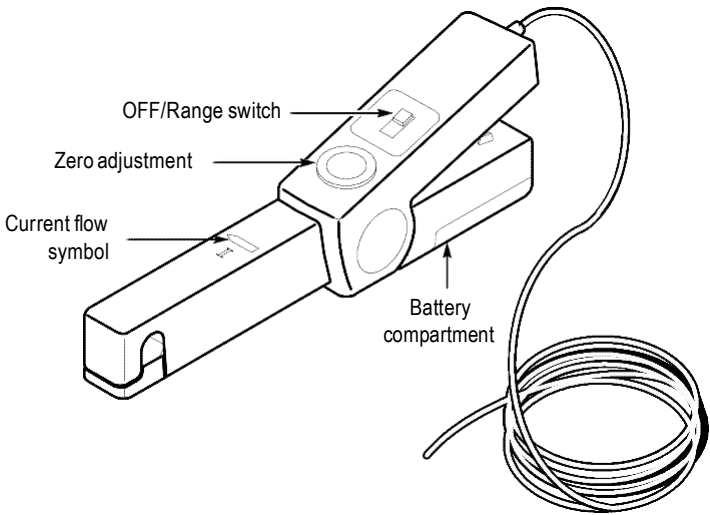
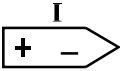
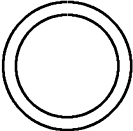
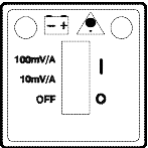
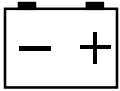



Figure 1: A622 AC/DC Current Probe

Table 1 highlights the controls and indicators on the A622 current probe.

Table 1: A622 controls and indicators

Control/Indicator	Description
	<p>Current flow symbol. The arrow show the probe's polarity convention for measuring current flowing from positive to negative.</p>
<p>ZERO</p> 	<p>Zero adjustment. Rotate to adjust the probe output to zero when there is no current present. It may also be used to offset a DC signal component. Zeroing is not needed for AC measurements unless your instrument cannot isolate a DC component (if present).</p>
	<p>OFF/Range switch. Slide the switch from OFF to either the 10 mV/A or 100 mV/A range. When either range is selected, the probe is turned on, and the green battery indicator lights. If the indicator does not light, see <i>Battery Notes</i> and <i>Battery Installation</i> on page 7.</p>
	<p>Battery indicator. The green battery indicator lights when the probe is turned on. For more information, see <i>Battery Notes</i> and <i>Battery Installation</i> on page 7.</p>
	<p>Overload indicator. The red overload indicator lights if the measured signal is greater that the selected range capacity. Switch the probe to 10 mV/A if possible, or remove the probe from the circuit.</p>

Operating Basics

Before using the probe, the batteries must be installed. See the battery installation instructions on page 7.



WARNING. Do not clamp the probe onto circuits with voltages greater than 600 VAC. Personal injury or damage to the probe may result.

Always connect the probe to the instrument before clamping onto the circuit under test.

1. Connect the probe BNC connector to the oscilloscope input. Start by setting the oscilloscope channel vertical coupling to DC volts, the vertical deflection to 0.1 V/div.
2. Move the OFF/Range switch to the 10 mV/A or 100 mV/A position to power on the probe.

The A622 current probe has a green LED power/battery indicator. If the LED does not light, replace the battery.

3. Use the ZERO adjustment to zero or offset the probe output.
4. Connect the probe to the circuit by opening the jaws and clamping around the conductor. See Figure 2.

NOTE. Clamping around both the “hot” and neutral wires may give you a zero reading.

(Remember to unclamp the probe from the conductor before disconnecting it from your meter or instrument.)

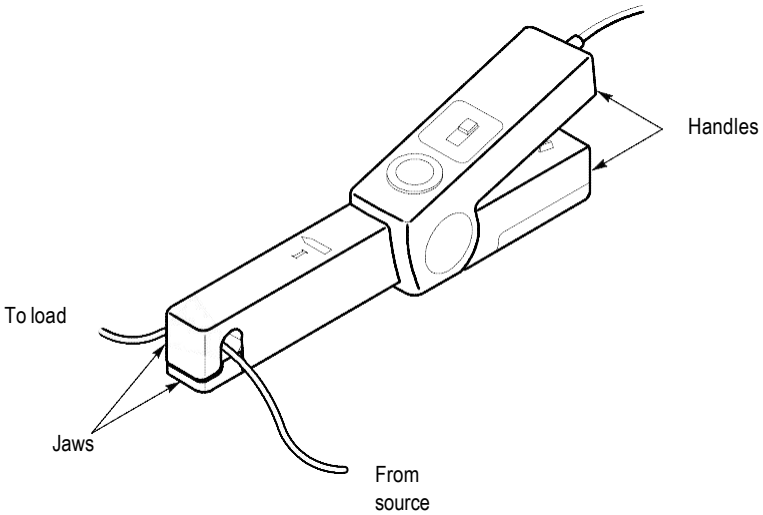

Figure 2: Connecting the A622 current probe

5. Adjust the probe and channel as necessary to get a clear view of the signal. Set the channel to DC volts to see both the AC and DC currents; set the channel to AC to see the AC current only.

The current drawn by some devices looks much different than that of others. While the RMS current may be low, the momentary peaks may be quite high. Figure 3 shows the difference between the line current drawn by a resistive load and a motor controller.

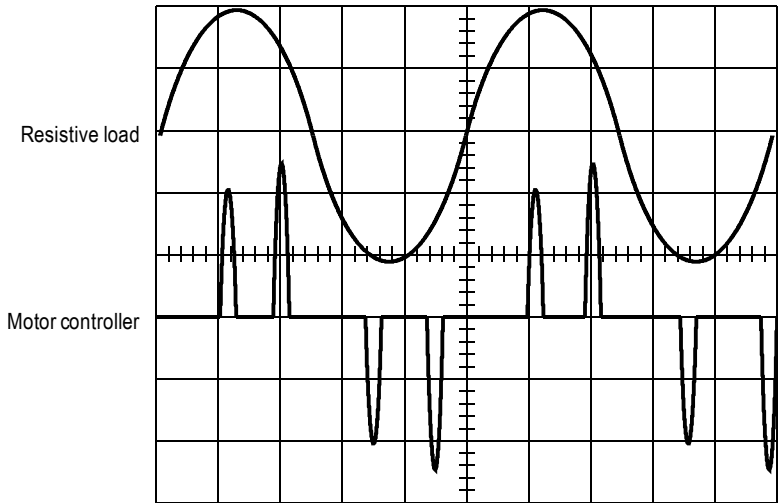

Figure 3: Typical current waveforms

If you are using the A622 current probe with a multimeter, connect the probe with the recommended BNC-to-banana adapter. Connect the black lead to the meter COM, and the red lead to the V Ω input.

To measure only AC current, set the meter to measure AC volts.

To measure DC current, set the meter to measure DC volts. Note the current convention arrow on the probe to get the proper polarity reading.

To increase the measurement sensitivity of the A622 current probe, loop additional turns of the wire under test through the jaws. See Figure 4. The sensitivity of the A622 current probe is multiplied times the number of loops in the jaws. For example: 10 mV/A X 4 turns = 40 mV/A.

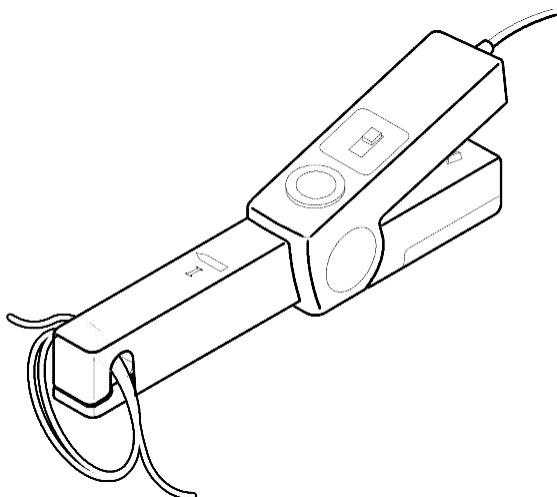

Figure 4: Increasing the sensitivity

Maintenance

Use the information in this section to properly maintain the operation of your A622 AC/DC Current Probe.

Battery Notes

The A622 current probe uses a single 9 V battery. Refer to page 9 for a detailed battery description.

As the battery in the A622 current probe is drained, significant gain errors may occur. The green LED will continue to light until a low battery voltage of 6.5 V is reached.

If probe gain errors are detected, replace the battery with a fresh one.

Battery Installation

1. Remove the probe from the circuit.
2. Open the battery compartment by loosening the captive screw and sliding the cover off. See Figure 5.
3. While observing polarity, attach the battery to the battery connector.
4. Replace the cover and lightly tighten the screw to hold the cover in place.

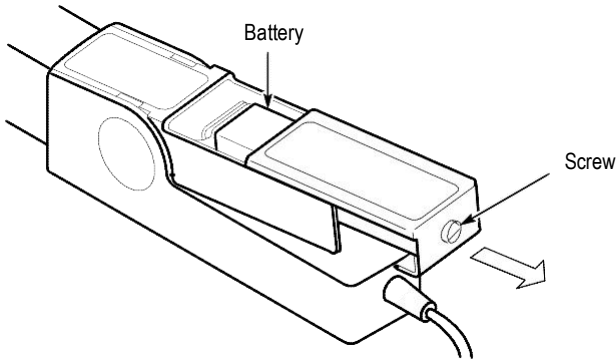

Figure 5: A622 battery compartment

Cleaning

To clean the probe body, use a soft cloth dampened in a solution of mild detergent and water. To clean the core, open the jaw and clean the exposed core surfaces with a cotton swap dampened with isopropyl alcohol (isopropanol). Lubricate the jaws mating surfaces with a light oil.

Do not clean with solvents or abrasives. Do not immerse the probe.

Preparation for Shipment

If the original packaging is unfit for use or not available, use the following packaging guidelines:

1. Use a sturdy shipping carton having inside dimensions at least one inch greater than the probe dimensions.
2. Put the probe into a plastic bag or wrap to protect it from dampness.
3. Place the probe into the box and stabilize it with light packing material.
4. Seal the carton with shipping tape.

Specifications

These characteristics apply to an A622 AC/DC Current Probe installed on a Tektronix TDS 220 oscilloscope. The oscilloscope must be warmed up for at least 20 minutes and be in an environment within the limits in Table 5.

Table 2: Electrical Characteristics

Current Ranges	10/100 mV/A
DC Accuracy, typical	$\pm 3\% \pm 50$ mA at 100 mV/A (50 mA to 10 A peak range) $\pm 4\% \pm 50$ mA at 10 mV/A (500 mA to 40 A peak range) $\pm 15\%$ max at 10 mV/A (40 A peak to 100 A peak range)
Gain versus frequency, typical	See Figure 6
Maximum Working Current	See Table 3
Maximum Working Voltage	See Table 3
Maximum Float Voltage	See Table 3
Frequency Range	DC to 100 kHz (-3 dB)
Battery Type and Life, typical	9V NEDA 1604A, IEC 6LR61 40 hours minimum (1 each)
DC signal linearity, typical	See Figure 8
Phase shift, typical	See Figure 9

Table 3: Voltage and current ratings

Rating	Maximum working current (A)		Maximum working voltage (V)	Maximum floating voltage (V)
	Range 10 mV/A	Range 100 mV/A		
DC	100 ¹	10	600	600
DC + peak AC	100 ¹	10	600	600
AC peak	100	10	600	600
AC peak-peak	200	20	1200	-
RMS CAT III	70.7	7.07	600	600
RMS CAT II	70.7	7.07	600	600
RMS CAT I	70.7	7.07	600	600

¹ See Figure 7 for frequency derating

Table 4: Physical Characteristics

Dimensions	231 mm x 36 mm x 67 mm (9.09 x 1.42 x 2.64 inches)
Maximum Conductor Size	11.8 mm (0.46 inches)
Cable Length	2 m (6.6 feet)
Weight	330 g (12 oz) with battery

Table 5: Environmental Characteristics

Temperature	
Working	0°C to +50°C (+32° to +122°F)
Storage	-20°C to +80°C (-4° to +176°F)
Humidity	
	0° C to 40° C, 95% humidity 40° C to 50° C, 45% humidity
Pollution Degree	2

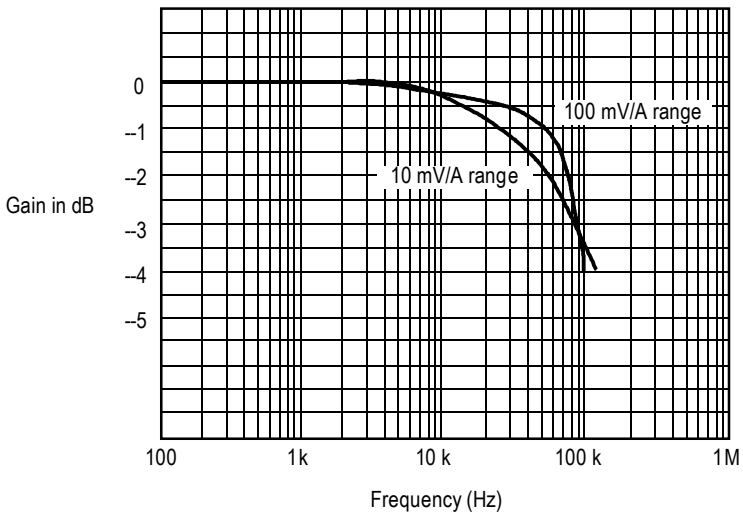

Figure 6: Gain versus frequency at 1 A peak, typical

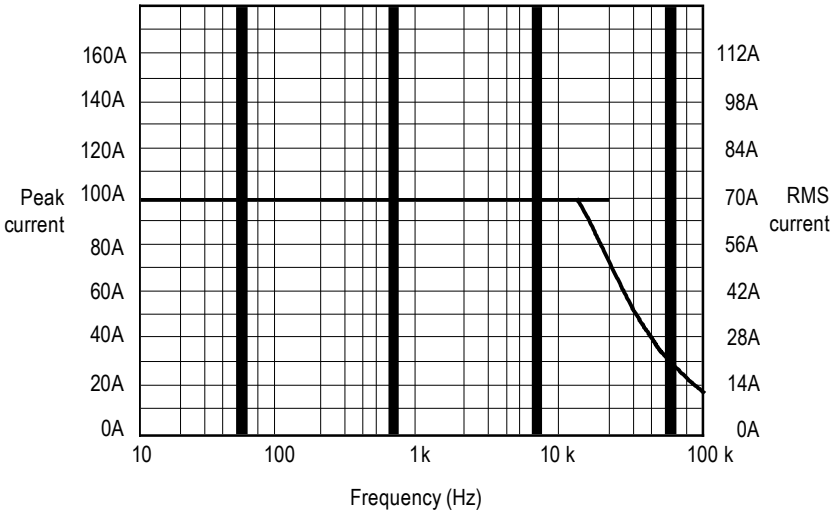

Figure 7: Maximum current versus frequency

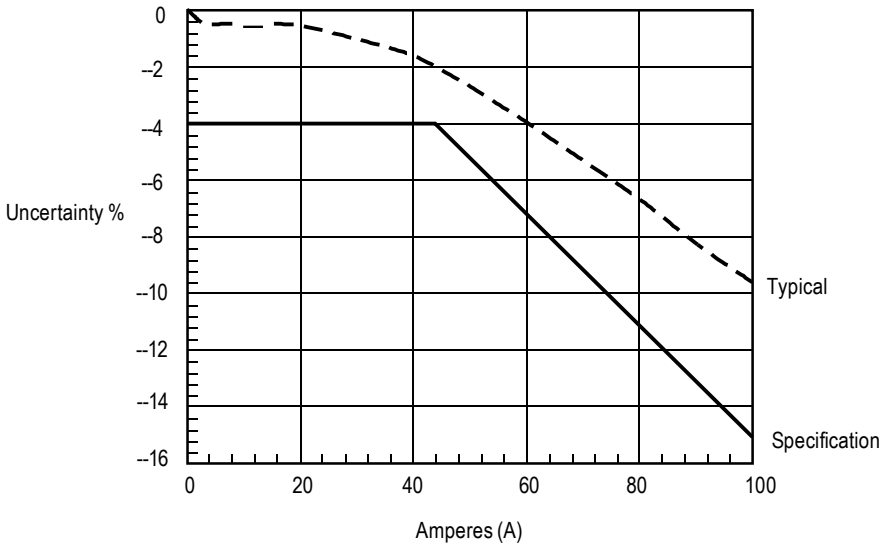

Figure 8: DC signal linearity in the 10 mV/A range, typical

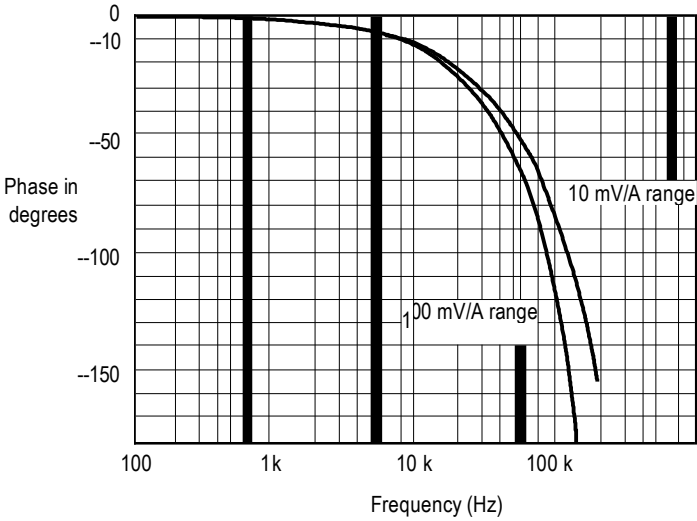

Figure 9: Phase versus frequency at 1 A peak, typical

Table 6: Certifications and compliances

<p>EC Declaration of Conformity - Low Voltage</p>	<p>Compliance was demonstrated to the following specification as listed in the Official Journal of the European Union:</p>
	<p>Low Voltage Directive 73/23/EEC, as amended by 93/68/EEC</p>
	<p>EN 61010-1/A2:1995</p>
	<p>Safety requirements for electrical equipment for measurement, control, and laboratory use.</p>
	<p>EN 61010-2-032:1995</p>
	<p>Particular requirements for hand-held current clamps for electrical measurement and test equipment.</p>

Table 6: Certifications and compliances (cont.)

U.S. Nationally Recognized Testing Laboratory Listing	<p>UL3111-1 Electrical Measuring and Test Equipment</p> <p>UL3111-2-032 Particular requirements for hand-held current clamps for electrical measurement and test equipment.</p>
Additional Compliance	<p>IEC61010-1/A2:1995 Safety requirements for electrical equipment for measurement, control, and laboratory use.</p> <p>IEC61010-2-032:1994 Particular requirements for hand-held current clamps for electrical measurement and test equipment.</p>
Installation (Overvoltage) Category	<p>Terminals on this product may have different installation (overvoltage) category designations. The installation categories are:</p> <p>CAT III Distribution-level mains (usually permanently connected). Equipment at this level is typically in a fixed industrial location.</p> <p>CAT II Local-level mains (wall sockets). Equipment at this level includes appliances, portable tools, and similar products. Equipment is usually cord-connected.</p> <p>CAT I Secondary (signal level) or battery operated circuits of electronic equipment.</p>

Table 6: Certifications and compliances (cont.)

Pollution Degree	<p>A measure of the contaminates that could occur in the environment around and within a product. Typically the internal environment inside a product is considered to be the same as the external. Products should be used only in the environment for which they are rated.</p> <p>Pollution Degree 1 No pollution or only dry, nonconductive pollution occurs. Products in this category are generally encapsulated, hermetically sealed, or located in clean rooms.</p> <p>Pollution Degree 2 Normally only dry, nonconductive pollution occurs. Occasionally a temporary conductivity that is caused by condensation must be expected. This location is a typical office/home environment. Temporary condensation occurs only when the product is out of service.</p>
------------------	--

Replaceable Parts

The A622 AC/DC Current Probe is shipped with the following items:

- These instructions
Tektronix part number 070-8883-XX
- One 9V battery
Tektronix part number 146-0017-00
ANSI/NEDA number 1604A
IEC number 6LR61

Recommended accessory for use with DMM's:

- One BNC to banana plug adapter
Tektronix part number 012-1450-00

The A622 does not have any user repairable assemblies. If you should have trouble with your probe, contact your local Tektronix Service Center or representative for help.



® 北京海洋兴业科技股份有限公司

北京市西三旗东黄平路 19 号龙旗广场 4 号楼(E座)906 室

电 话：010-62176775 62178811 62176785

企业 QQ：800057747

企业官网：www.hyxyyq.com

邮编：100096

传真：010-62176619

邮箱：info.oi@oitek.com.cn

购线网：www.gooxian.net



扫描二维码关注我们
查找微信企业号：海洋仪器